

# *Operation Manual*

## *W1024ML Wheel Balancer*



Read these instructions before placing unit in service.

Keep these and other materials with the unit in a binder near the machine for easy reference by supervisors and operators.

***Installation - Operation - Maintenance***

## 4.4 KEYPAD OVERVIEW

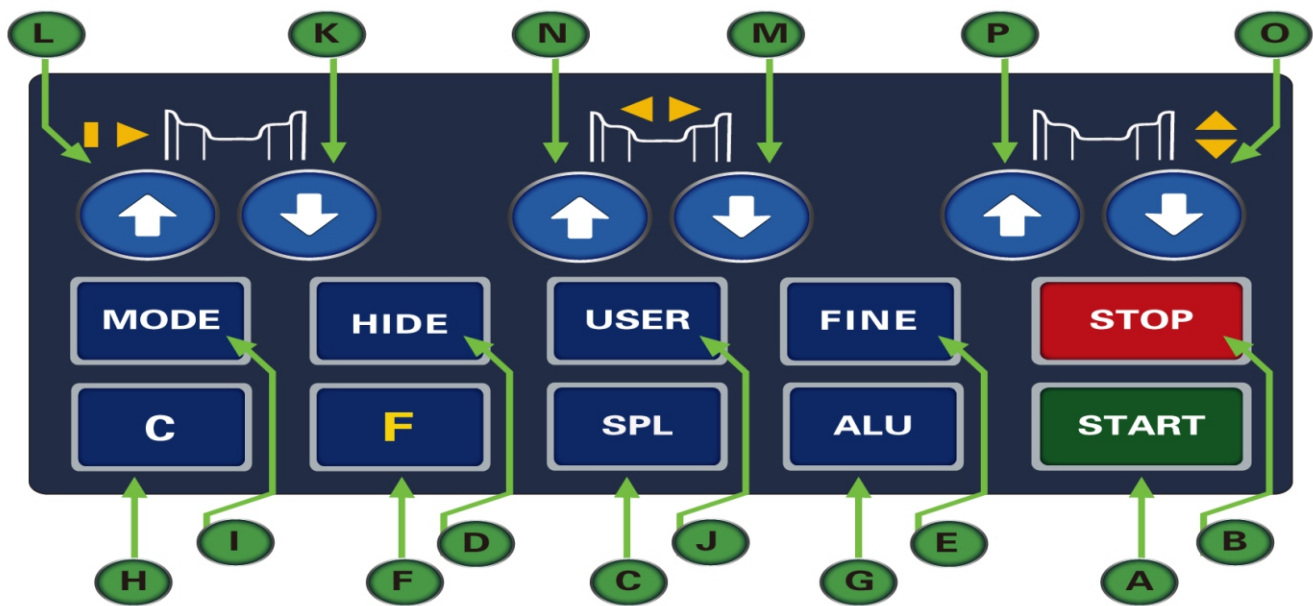

**A** **START** **START Key:** Press the **START** key to start a spin cycle. Note: Lower the protection hood to activate a spin cycle.

**B** **STOP** **STOP Key:** Press **STOP** key to perform the following functions in each different status:

- Stop spin cycle in emergency when the wheel is spinning
- Activate the wheel lock (solenoid brake) when the wheel is not spinning, deactivate it by pressing **STOP** key again.

**C** **SPL** **SPL Key:** Press the **Smart Position Locator** key to locate the wheel to the balancing weight position.

**D** **HIDE** **HIDE Key:** Press this key to enter the hidden weight function (behind the spokes) when ALU-S program is activated.

**E** **FINE** **<T Key:** Press this key to indicate actual imbalance weight amount reading below 5 grams or ¼ ounce.

**F** **F** **Fn / Static Key:** Press this key to toggle between dynamic and static balancing modes.

**G** **ALU** **ALU Key:** Press this key to select a balancing program, corresponding modes will be indicated on the balancing mode indicator.

**H** **C** **C Key:** Press this key to perform the following functions in each different status:

- Recalculate the balancing result after a test spin done, after changing either of A, W and D data, press C key to do recalculation without additional spin;
- Exit program during in process of some programs such as OPT and HIDE, details are described in the specific sections;

**CAUBRATION.** Press Fn + C key to enter calibration procedure. See details in the calibration chapter.

**I** **MODE** **Vehicle Selection (MODE) Key:** Press this key to select the vehicle wheel type.

**J** **USER** **USER Key:** Repeat pressing this key to toggle to choose the desired user working environment.  
Press Fn + USER key to save presetting data in each user environment.

**K** **"A-" Key:** Press this key to trim down value of rim distance **A**.

**L** **"A+" Key:** Press this key to raise up value of rim distance **A**.

**M** **"W-" Key:** Press this key to trim down value of rim width **W**.

**N** **"W+" Key:** Press this key to raise up value of rim width **W**.

**O** **"D-" Key:** Press this key to trim down value of rim diameter **D**.

**P** **"D+" Key:** Press this key to raise up value of rim diameter **D**.

**NOTE** The above listed 16 keys are all programmed with extended functions, either mode switching or program activating. Details are shown in the following sections.



## 2. Key combination overview

KEY COMBINATION	FUNCTIONS	KEY IN PROCEDURE
 	<p><b>Spin Mode Setting</b>  <b>Auto spin</b> = Wheel spin after protection hood is lowered down.  <b>Manual spin</b> = Wheel spin by pressing START key.</p> <p><b>NOTE</b> In calibration program, wheel spin by press START key.            Factory default setting is auto spin.</p>	<p>Press and hold the <b>STOP</b> key and then press the <b>C</b> key, hold for 5 seconds until both weight display windows are turned off. The spin mode changes when keys are released and the display window's lights are on. Lower the protection hood to check spin mode status.</p>
  	<p><b>Weight unit setting</b>            Set the weight units in Gram (g) or Ounce (oz).</p>	<p>Press and hold the <b>STOP</b> key, then press <b>A+</b> and <b>A-</b> keys, either <b>oz</b> or <b>g</b> indicator is illuminated upon the selection.</p>
  	<p><b>W and D Unit Setting - mm / inch</b>            Set the Width <b>W</b> and Diameter <b>D</b> unit between mm and inch.            The default setting is <b>inch</b>.</p>	<p>Press and hold the <b>STOP</b> key, then press <b>W+</b> and <b>W-</b> keys, LED located on <b>W</b> and <b>D</b> indicators are illuminated when the units are set to <b>mm</b>, or the indicators are off when they are set to <b>inch</b>.</p>
 	<p><b>Balancing Calibration</b>            To enter the unbalance weight calibration program.</p>	<p>Press both <b>Fn</b> and <b>C</b> keys to enter weight calibration program. See details in section <b>Balancing Calibration</b></p>
  	<p><b>Distance A Calibration</b>            To enter the Distance A calibration program.</p>	<p>Press <b>Fn</b> and <b>A+</b> or <b>A-</b> keys to enter Distance A calibration program. See details in section <b>Distance Calibration</b>.</p>
  	<p><b>Width W Calibration</b>            To enter the Width <b>W</b> calibration program.</p>	<p>Press <b>Fn</b> and <b>W+</b> or <b>W-</b> keys to enter Width <b>W</b> calibration program. See details in section <b>Width Calibration</b>.</p>
  	<p><b>Diameter D Calibration</b>            To enter the Diameter <b>D</b> calibration program.</p>	<p>Press <b>Fn</b> and <b>D+</b> or <b>D-</b> keys to enter Diameter <b>D</b> calibration program. See details in section <b>Diameter Calibration</b>.</p>
 	<p><b>Save User's Presetting Data</b>            To preset data in each user's environment.</p>	<p>Press the user key to toggle to the selected user number . Enter <b>A</b>, <b>W</b> and <b>D</b> data, then press <b>Fn</b> and <b>USER</b> keys to save data into the selected user environment.</p>
 	<p><b>Optimization (OPT) Program.</b>            To enter OPT program.</p>	<p>Press both <b>Fn</b> and <b>Vehicle-MODE</b> keys to enter OPT program. See detail in the section <b>OPT Optimization Program</b>.</p>
	<p><b>ALU-S Program.</b>            To enter ALU-S program.</p>	<p>Press <b>ALU</b> key to enter ALU-S program. See detail in the section <b>ALU-S Program</b>.</p>
 	<p><b>System Check Program</b>            Enter system check program to scan each Input and Output status.</p>	<p>Press both <b>Fn</b> and <b>SPL</b> keys to enter the system check program. When this program is activated, all indicators and display windows will be illuminated one by one, until the weight display windows prompts the scanning result. <b>NOTE</b></p> <p>This function is for service personal only.</p>
 	<p><b>Alterative Plane Static (APS) Program.</b>            To Enter the APS program.</p>	<p>Press both <b>Fn</b> and <b>HIDE</b> keys to enter APS program. See section <b>STATIC Balancing</b> for detail.</p>
KEY COMBINATION	FUNCTIONS	KEY IN PROCEDURE

### 3. WHEEL BALANCING



- Calibration is required when the wheel balancer is first put into operation at a fixed location, after it is moved to a new location or when the technician suspects the machine of providing incorrect values or when mechatronical main components have been replaced. It is recommended to perform a calibration every 3 months, but especially while having enormous possible changes of temperature during the seasons. The procedure of calibration is shown in section 5.

#### 3.1 MOUNTING A WHEEL ONTO THE SPIN SHAFT

Select the correct size centering-cone diameter that will ensure the wheel rim is tightly secured (no wobble) to the thread shaft. Insert the centering-cone to the spin shaft and partially through the center hole of the rim.

Please pay attention use cones and quick hub wing nut in the different fields of application!

Below are some of the different methods for the quick hub wing nut wheel mounting, choose the proper one in your application.

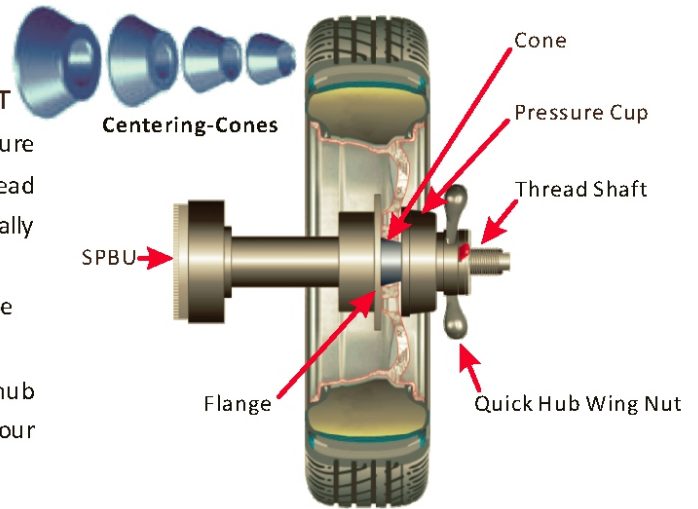

*Failure to tighten the Quick Hub Wing Nut properly may result in wheel self-dismounting, causing personal injury and property damage!*

#### 3.2 BACK CENTERING-CONE MOUNTING

The majority of original equipment rims and steel rims can be handled by using this procedure. The wheel is back-cone-centered, centering-cone from the INNER side of the hub.

- 1 Make sure the pressure cup is attached to the quick hub wing nut.
- 2 Select the centering-cone that best fits the center hole in the rim. Slide the centering-cone over the thread shaft with the larger diameter towards the flange, small diameter joining the center hole of the rim.
- 3 Lift the wheel onto the thread shaft and center it onto the centering-cone. Make sure to position the INNER side of the wheel rim against the flange and cone.

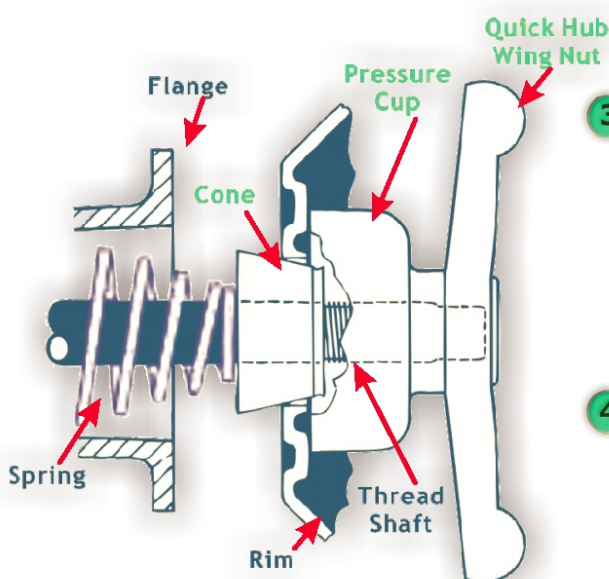

Back Centering-Cone Mounting



*Use the nylon spacer between rim and pressure cup to protect custom wheel finishes.*

- 4 Mount the quick hub wing nut with pressure cup onto the thread of the spin shaft and tighten it firmly against the rim. The quick hub wing nut should engage the threads for at least three full turns.



*If the quick hub wing nut will not tighten completely, use the front centering-cone mounting method.*



### 3.3 FRONT CENTERING-CONE MOUNTING

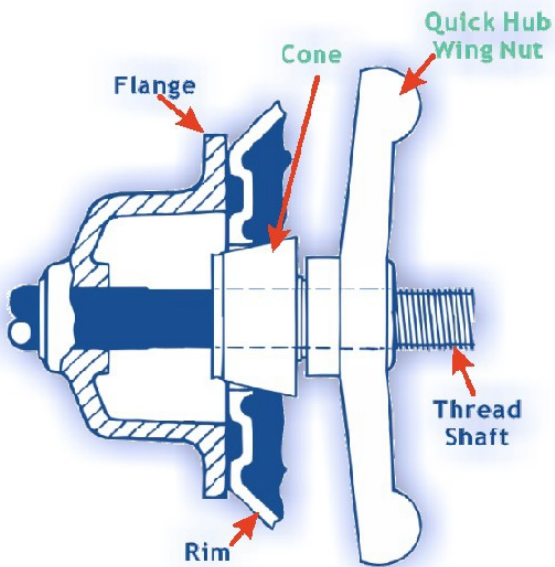

Front Centering-Cone Mounting



**ATTENTION** A wheel should only be centered with this method when the type of the INNER surface of the rim is not convenient to provide an accurate centering seat.

For wheel without center hole you must use the optional Universal Adaptor.

For Universal Adaptor details see in the Original Equipment Manufacturer's manual.

The wheel is front-cone-centered, centering-cone from the outer side of the hub.

- 1 Make sure the pressure cup is **NOT** attached to the quick hub wing nut.

Select the centering-cone that best fits the center hole in the rim.

- 2 Lift the wheel onto the threaded spin shaft and slide it back against the shaft flange. Make sure to position the **INNER** side of the wheel rim against the flange.

- 3 Slide the centering-cone onto the shaft into the middle of the wheel rim. It is necessary to lift the wheel to get the centering-cone placed in the center hole.

- 4 Fit the quick hub wing nut without pressure cup onto the spin shaft.

Tighten it securely against the centering-cone. The hub wing nut must engage the threads for at least three full turns.

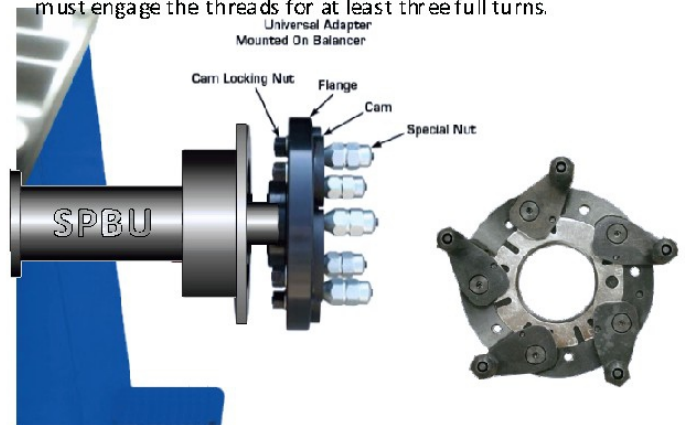

Universal Adaptor Mounting (optional)



#### Quick Hub Wing Nut



The **handles** of the Quick Hub Wing Nut **must not touch** the rim surface as this type of pressure may damage the wing nut which may lead to fractures. And as well it can cause scratches to custom wheel finishes.

# QUICK HUB WING NUT

## Quick Hub Wing Nut

The Kit Includes:

- 1** Quick Hub Wing Nut
- 2** Clamping hood small with snap-fit (for steel rims)
- 3** Rubber Sleeve (for clamping hood)
- 4** Standard Pressure ring with snap-fit (for Quick Hub Wing Nut)

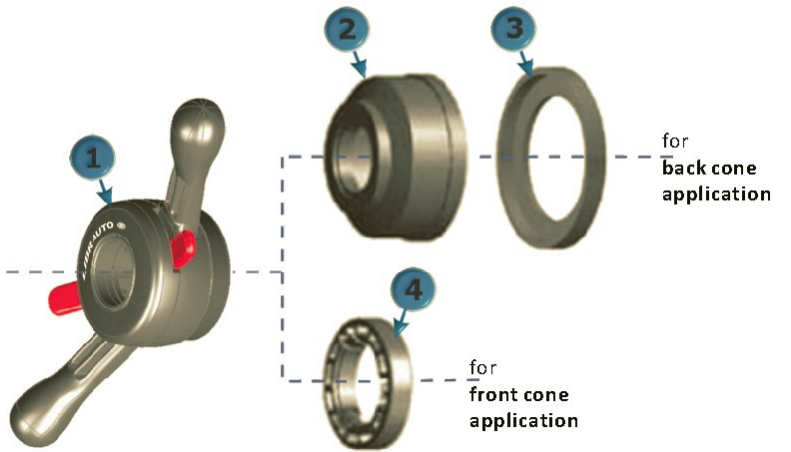

## Cone and Quick Hub Wing Nut Mounting

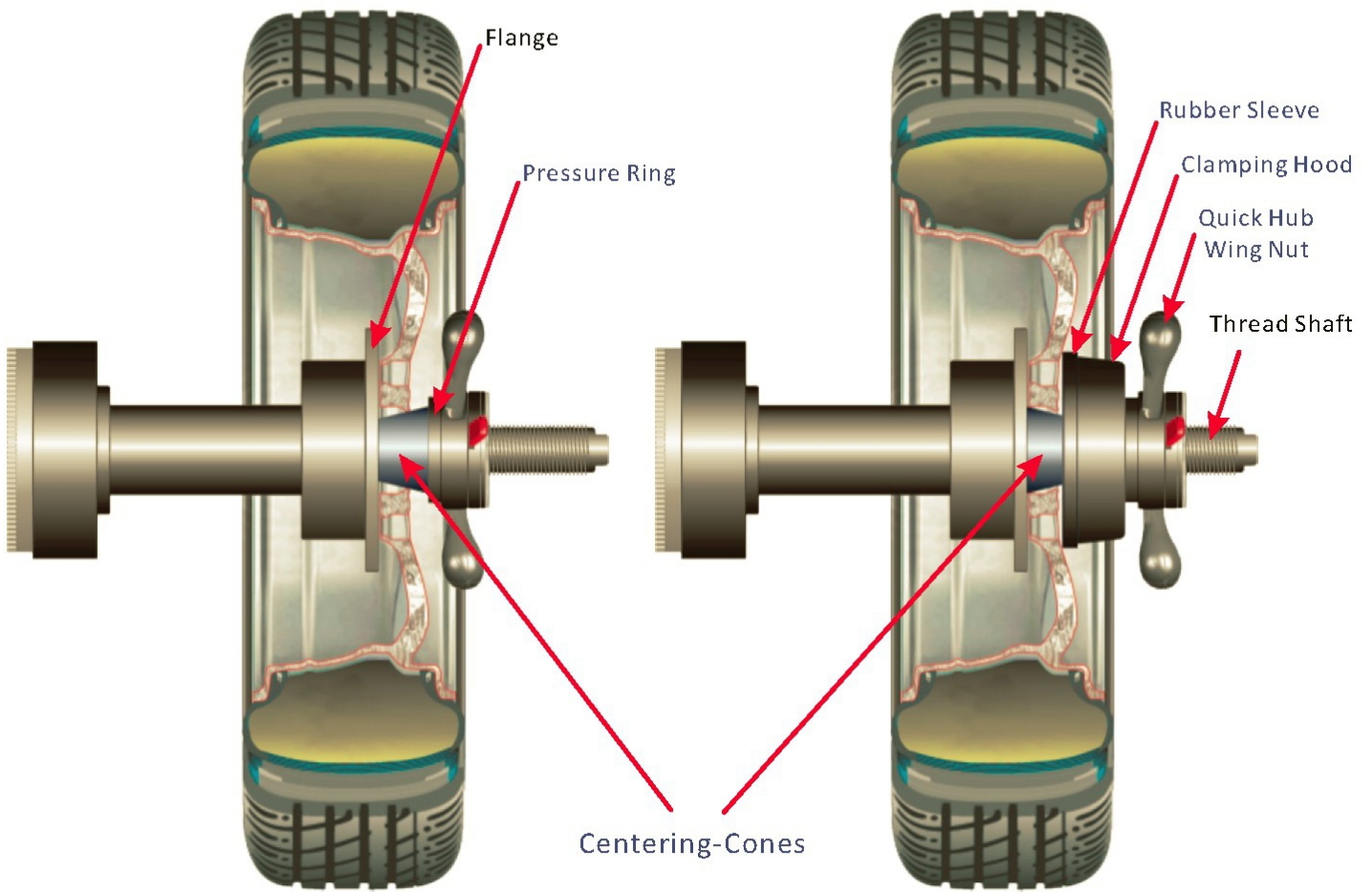

Front Centering-Cone Mounting

Back Centering-Cone Mounting



## 3.4 ENTER WHEEL DATA

Wheel dimension data must be entered into the computer before a wheel can be balanced. There are 2 ways to enter wheel data A, D and W, manual entry and automatic entry.

### DEFINITIONS OF THE WHEEL DATA

<b>A</b> = Distance	The distance is measured from the wheel balancer to the <b>INNER</b> plane of the rim (INNER weight location).
<b>W</b> = Width	The width of the rim at the rim flange.
<b>D</b> = Diameter	The rated diameter of the rim, it is indicated on the tire.

## 3.5 MANUAL DATA ENTRY

For manual entry models, wheel data can be entered manually through the key pad.

### Step 1 : Rim Distance **A**

After properly mounting the wheel on the machine spin shaft, pull out the front measuring arm from the home position and move it to contact on the left side of the rim.

Read the scale on the ruler to obtain the distance value on between the machine body and the wheel.

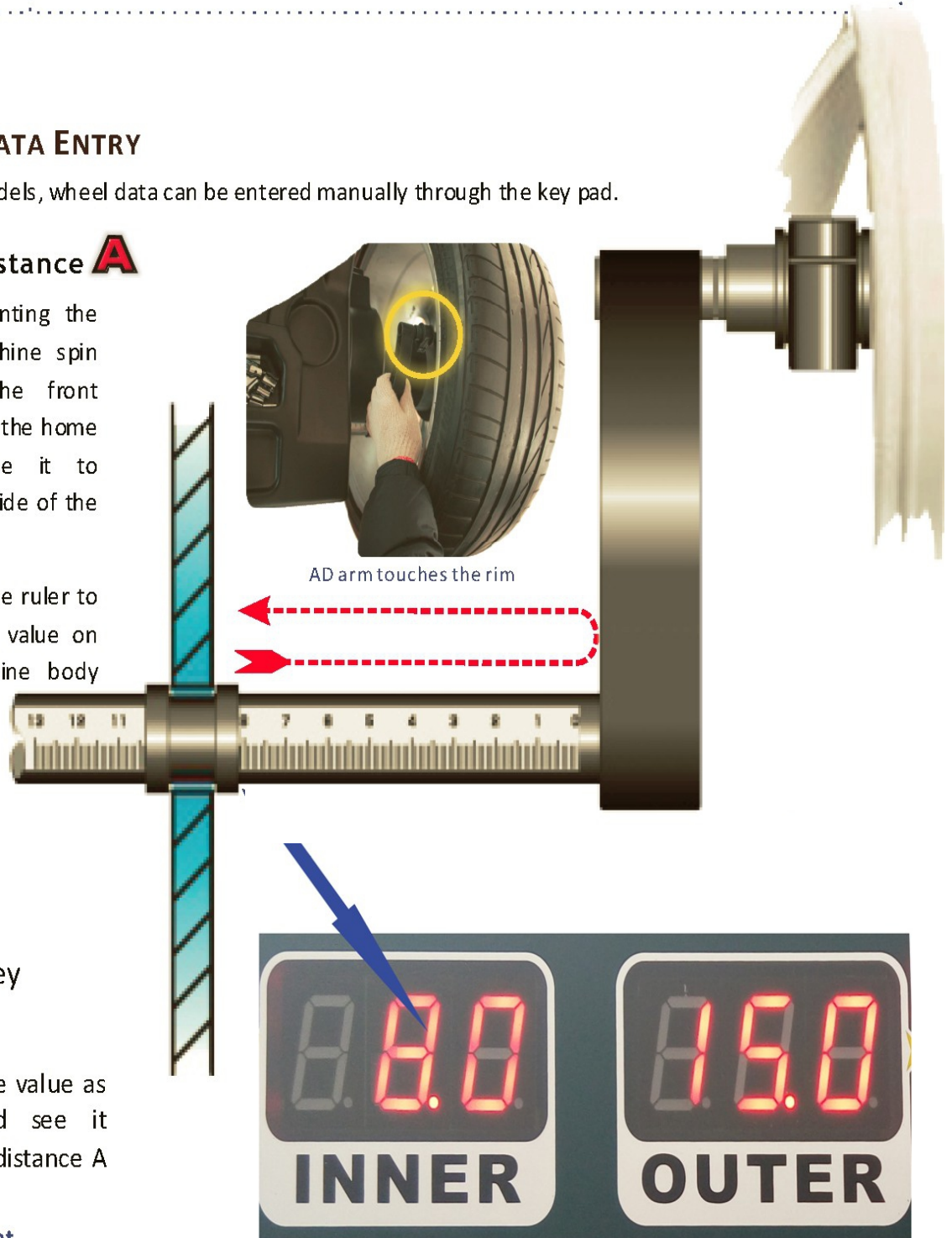

Step 2 :

Rim Diameter **D**

European Tyre and Rim Technical Organisation (ETRTO) 

# Metric Units

(TRA) Tire and Rim Association of America 

# Imperial Units

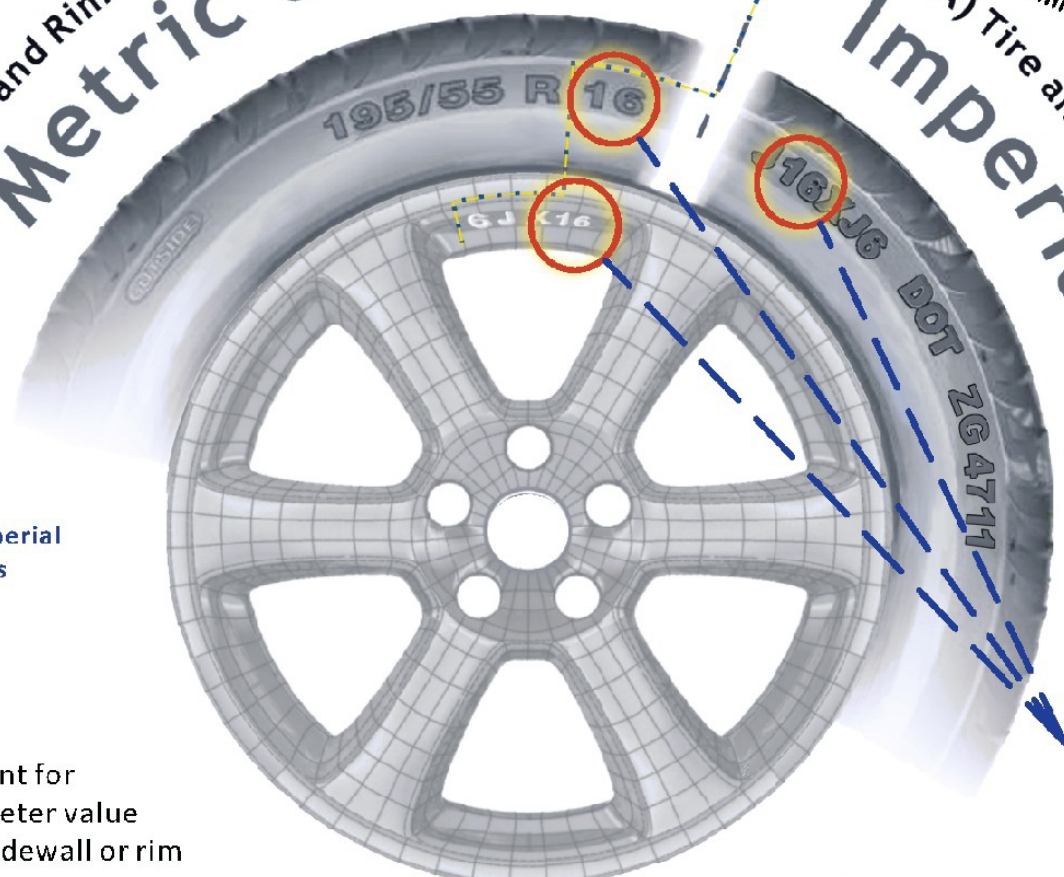

Metric & Imperial Units on tires

Read imprint for rated diameter value from tire sidewall or rim and manually, put in the data.

**D** in Inch

Press D+ or D- key

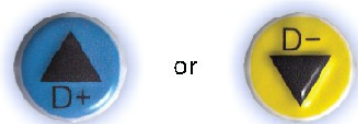

Distance Keys

to set the rim diameter accordingly.

Accomplishment



Step 3 :

Rim Width **W**

Measure width of the rim with caliper provided

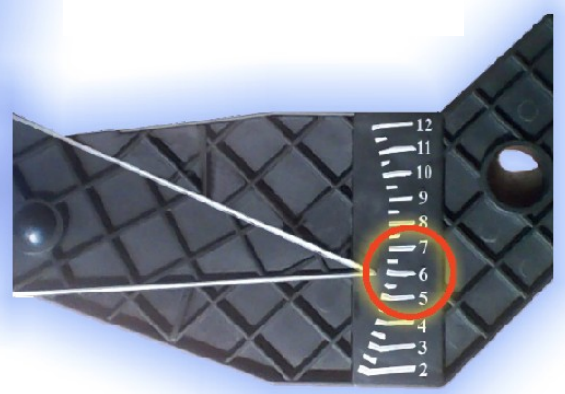

Caliper reads: "6 inch width"



Press W+ or W- key

to set the rim width as per value read from the provided caliper.

Accomplishment



or



Distance Keys

Alternatively read imprint for Width from wheel sidewall or rim and manually put in the data.

Metric & Imperial Units on tires

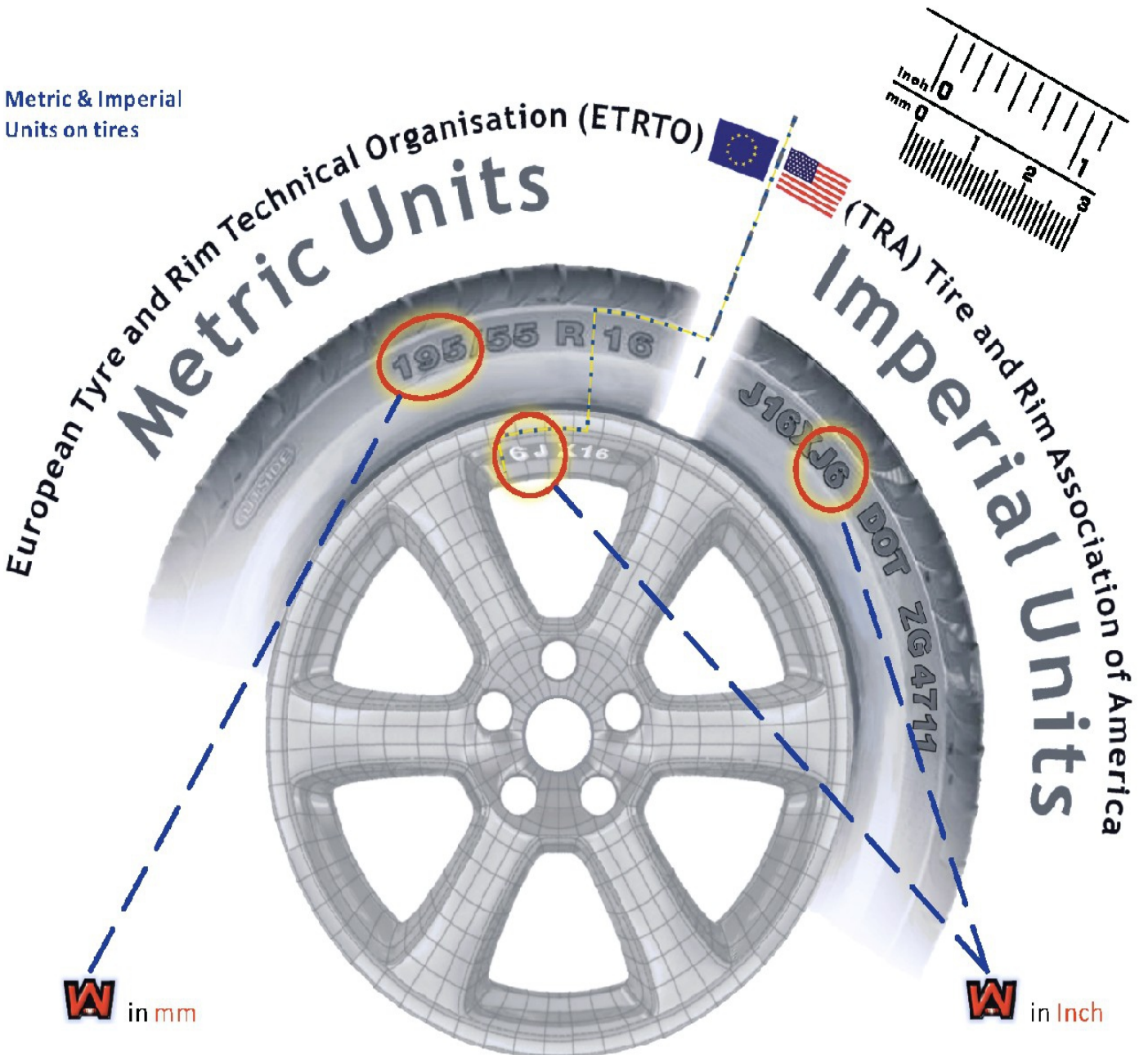





### 3.6 AUTOMATIC DATA ENTRY

For auto entry models, wheel data can be set automatically with the electronic measuring arms built in the machine. The front measuring arm is for taking measurement of wheel distance A and rim diameter D, and the rear measuring arm is for the rim width W.

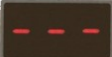

Step 1 :

Distance **A** and Rim Diameter **D**

- 1 Bring out the measuring arm and make the tip (stick weight holder clip) contact on the **INNER** side of the rim,
- 2 hold it until the display windows A and D shows  and ,
- 3 return the arm back to the home position,
- 4 the display windows A and D are now showing the values acquired.  
(Example:  and  ).

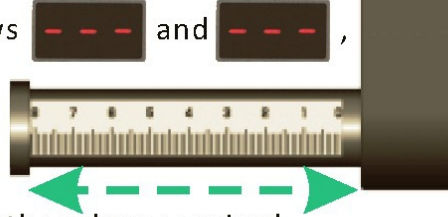

**ATTENTION** *Position of the measuring arm shall be correctly placed to ensure accurate data acquisition. If an incorrect value has been acquired during measurement, move the arm back to home position and repeat the operation.*

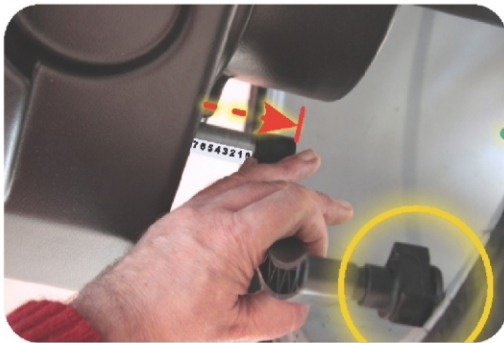

- 1 AD arm touches inboard rim flange (AD arm in read data position)



- 2 Display A and D shows:

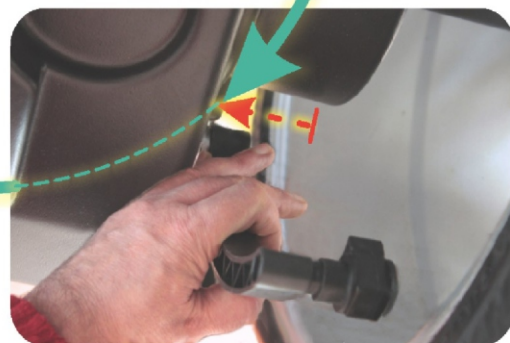
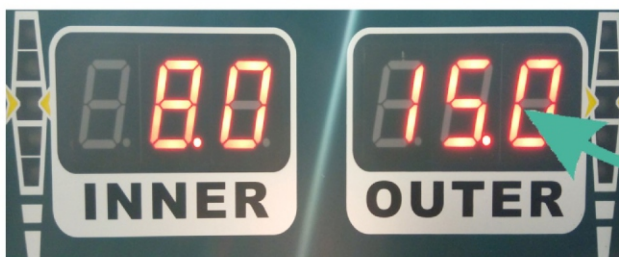



- 4 Display A (distance) and D (diameter) with digits acquired

- 3 AD arm pulled back from inboard rim flange to home position

continued 



## Step 2 : Rim Width **W**

Move the pointer of the rear measuring arm to the outboard rim flange, as shown in the pictures followed, hold it until the display window **W** is showing , and rest it back to the home position, the display shows digits as the data acquired. (Example:  )

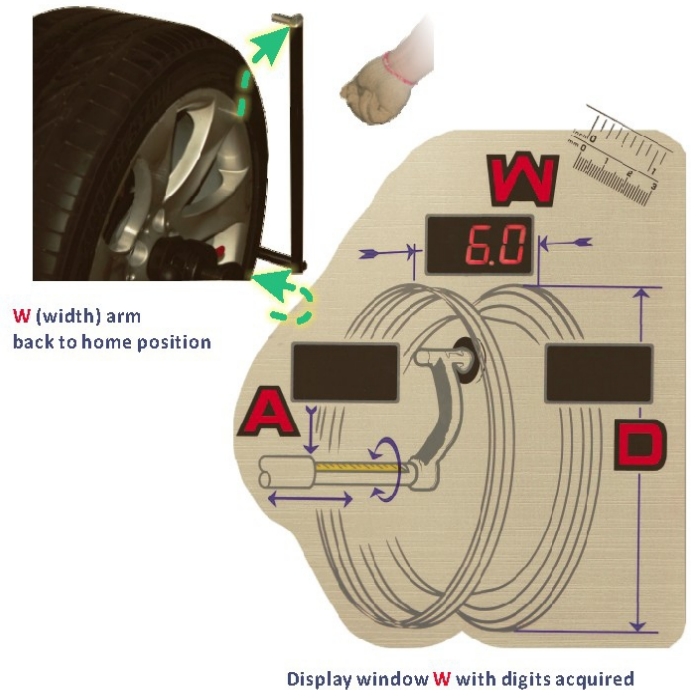
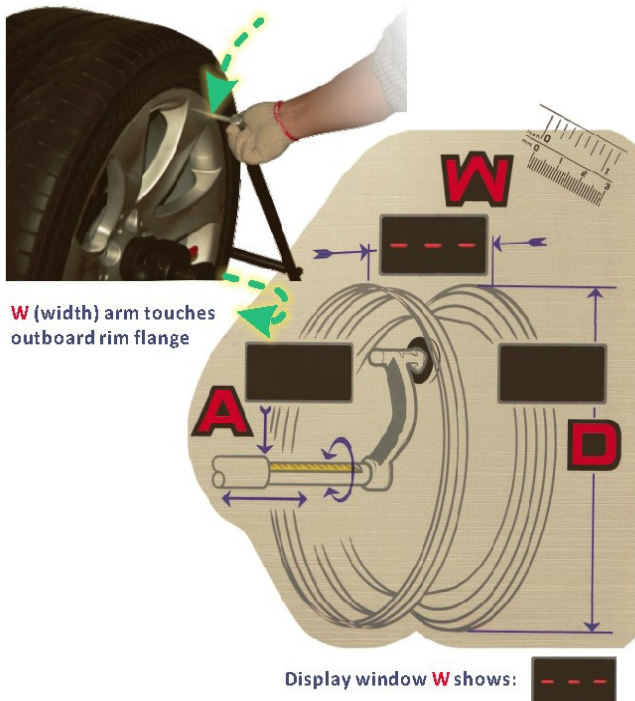

### **NOTE**

If your machine is not built with the rim width measurement arm, enter the width value manually according to the procedure described in [section 4.7.1](#). Data can also be entered by hand for auto entry models.

## 3.7 USER DATA PRESETTING

Four different user data can be preset to the memory to save operation time.

To preset a wheel data into one of the four user environments, repeat pressing the USER key to toggle to a desired user working environment (for example user 2), the corresponding user number is illuminated, as illustrated in the picture followed, enter wheel data A, W and D manually or with the automatic measuring arms, simultaneously press Fn and USER key, the user 2 wheel data are now preset stored to the memory.

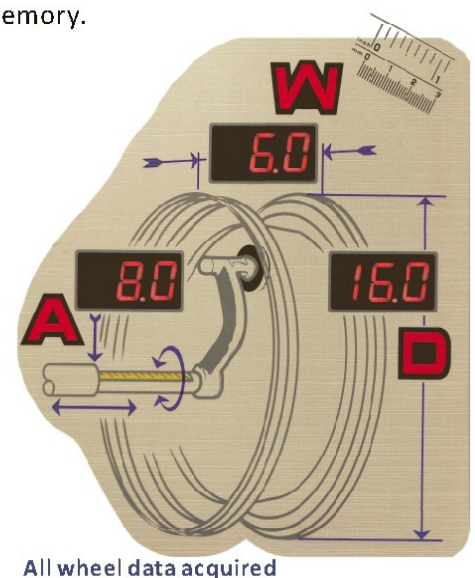
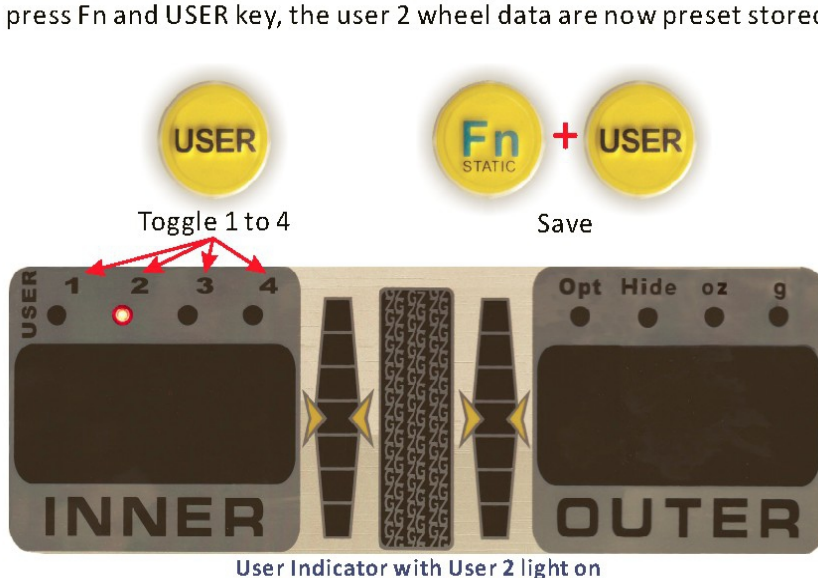

## 4.0 BALANCING PROGRAMS

### Vehicle Type Selection

There are 2 different vehicle wheel types programmed in the wheel balancing unit:

#### Motor Cycle Wheel



#### Car & Light Truck Wheel



To change the type

press Vehicle Selection (MODE) Key



to select the vehicle wheel type. The vehicle type indicator is illuminated upon selection.

The default setting is: Car & Light Truck Vehicle Wheel.



**ATTENTION** Before balancing operation, the following primary preparation steps must be done:

- 1 Mount the wheel onto the spin shaft; follow-up the procedures described in section MOUNTING A WHEEL ONTO THE SPIN SHAFT.
- 2 Remove any counter weight, pebble, dirt or other foreign materials from the wheel.
- 3 Set the wheel data as per procedure mentioned in section ENTER WHEEL DATA.

## G2 PROGRAMS

The following table presents the available programs in the balancing unit. Follow the instruction listed on "key to access" column to enter the program needed.



# BALANCING PROGRAMS

MODE

PROGRAM

DISPLAY

KEY TO ACCESS

# DYNAMIC

Standard

标准



ALU-1



ALU-2



ALU-3

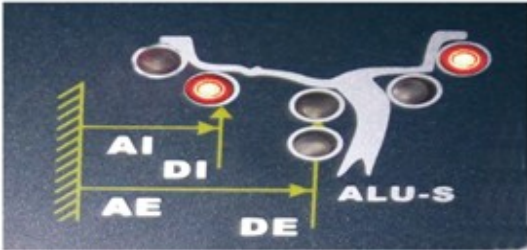

ALU-4



ALU-5



Use the

**ALU** key

to toggle between program modes in sequence.

**ALU**

MODE

PROGRAM

DISPLAY

KEY TO ACCESS

# BALANCING PROGRAMS

MODE	PROGRAM	DISPLAY	KEY TO ACCESS
<b>DYNAMIC</b>	Hide & Split ALU-S		Press <b>HIDE</b>  when the program entered in ALU-S
	OPT Optimization		Press <b>Fn + Vehicle Mode</b> +
<b>STATIC</b>	Standard STATIC		Press <b>Fn</b> 
	APS Alternative Plane STATIC		Press <b>Fn + Hide</b> +
	Motorbike STATIC		Press <b>Vehicle Mode</b> 
	Motorbike DYNAMIC		Press <b>Vehicle Mode</b>  then ALU
MODE	PROGRAM	DISPLAY	KEY TO ACCESS



## 4.1 STANDARD DYNAMIC BALANCING

This mode is the most commonly used balancing program, the wheel balancer sets standard dynamic balancing as default mode. As shown in the picture, the balancing mode indicator is in standard dynamic balancing mode, which shows clip on type weights are to be fitted on both sides of the rim flange.



### Procedures:

- 1** Set the wheel data.
- 2** Spin the wheel.  
Lower the protection hood, the wheel spins automatically, as the wheel spins, all indicators and display windows on the display panel are turned off until the wheel stops, the balancing results are indicated on both weight display windows as illustrated in the picture followed.



Left and right weight display windows



*Do not apply any undue stress to the machine during wheel spin to obtain most accurate result.*



*Do not operate the machine without protection hood. Never raise the protection hood before the wheel stopped. Keep hair, loose clothing, fingers and all parts of body away from moving parts.*



*To terminate a spin process, press STOP*



*key.*

- 3** Raise the protection hood.
- 4** Weight position search. Two methods are available in this machine: Manual search and Automatic search (SPL), the user can choose one of them during operation.

# MANUAL POSITION SEARCH

**STEP 1** To search first weight position (i.e. **INNER** (left) side), rotate the wheel with hand, as indicates on the weight position indication bar, turn the wheel backward (reverse spin direction) or forward (spin direction) until all lights of the indication bar are illuminated, hold the wheel for about 1 second, the locking device activated to restrain the wheel in the position

## Indication Bar Display

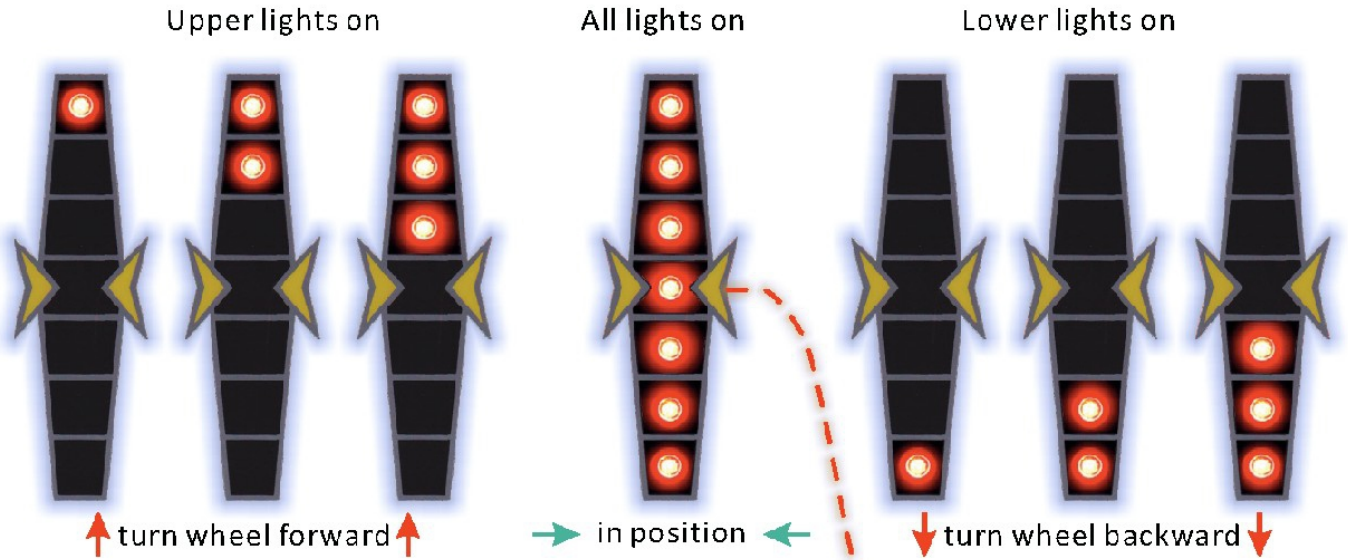

**STEP 2** Apply a balancing weight with displayed amount to the **INNER** plane in "TDC" (Top Dead Center) position of the rim.

At 12 o'clock, the highest point of the rim = 0°.





**Step 3 :**  Press **STOP** key to unlock the wheel (user can also turn the wheel backward to unlock the wheel), search 2<sup>nd</sup> weight position (i.e. **OUTER** (right) side) with the same way described on step ①.

**Step 4 :** Apply a balancing weight with displayed amount to the **OUTER** (right) plane in the position on the rim at top dead center 12 o'clock.

### Automatic Position Search (SPL)

**Step 1 :**  Press the **SPL** key (**SPL** = **S**mart **P**ositioning **L**ocator), the wheel rotates slowly, the **INNER** (left) weight positioning bars are fully illuminated as the wheel stops at the **INNER** (left) correction weight position (Top Dead Center of the rim).

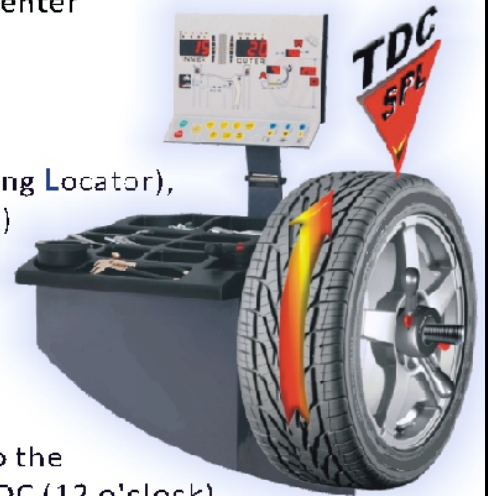

**Step 2 :** Apply a balancing weight with displayed amount to the **INNER** (left) plane in the position onto the rim at TDC (12 o'clock).

**Step 3 :**  Press the **SPL** key (**SPL** = **S**mart **P**ositioning **L**ocator), the wheel rotates slowly, the **OUTER** (right) weight positioning bars are fully illuminated as the wheel stop at the **OUTER** (right) correction weight position (TDC of the rim).

**Step 4 :** Apply a balancing weight with displayed amount to the **OUTER** (right) plane in the position onto the rim at TDC (12 o'clock).

#### **NOTE**

*SPL might locate at a position very close to TDC due to wheel weight deviation. Slightly rotate the wheel forwards or rearwards until you get the buzzer sound.*

**C**

Press key **C** to exit the SPL program.

**5**

After balance weights applied on the wheel, lower the protection hood, and proceed a test wheel spin to check the balancing result. The result shall be zero on both weight display windows if correct weights are applied to the correct positions.

#### **NOTE**

*During applying weights to verify the wheel balance, positioning error might happen, and a few degrees error might cause a residual unbalance as large as 5-10 grams, especially in case of large unbalance.*

*In practical wheel balancing operations, available counter weights are 5 grams increments, i.e. 5, 10, 15...60 grams etc. However, an actual unbalance results might be any grams in between, for example, when there is a 23 grams unbalance in actual, and the program will suggest 25 grams to balance it.*

*The facts described above might cause an unsatisfied balancing result, if such cases happen, it is recommended to remove the applied weights from the rim and redo the balancing.*

## Procedures:

- Step 1** :  Press ALU key to toggle the suitable program for your application.
- Step 2** : Enter Wheel data A, W and D as per the procedures described in section [Enter Wheel Data](#).
- Step 3** : Perform a wheel spin as per indication described in the section of Standard Dynamic Balancing.
- Step 4** : Search the weight position according to the procedure described in the section of Standard Dynamic Balancing.
- Step 5** : Apply balancing weights as per the selected ALU program illustrated.
- Step 6** : Proceed a test spin to check the balancing correction result.

### NOTE

*Some slight residual unbalances may remain at the end of the test spin due to the considerable difference in shape that maybe found on rims with same rated dimensions. Therefore, if the standard ALU programs are not giving a satisfy balancing result, choose the variable plane program ALU-S to have correct balancing.*

## 4.8.3 ALU-S PROGRAM (VARIABLE PLANE PROGRAM)

This program makes it possible to apply adhesive weights in user selected positions. It is used for maximum precision balancing of light alloy rims that require both weight to be apply on the same side (**INNER** (left) side).

Press  ALU keys enter the programs until the light over the mark "**ALU-S**" illuminates, as illustrated, 3 lights on the balancing mode indicator are illuminated.



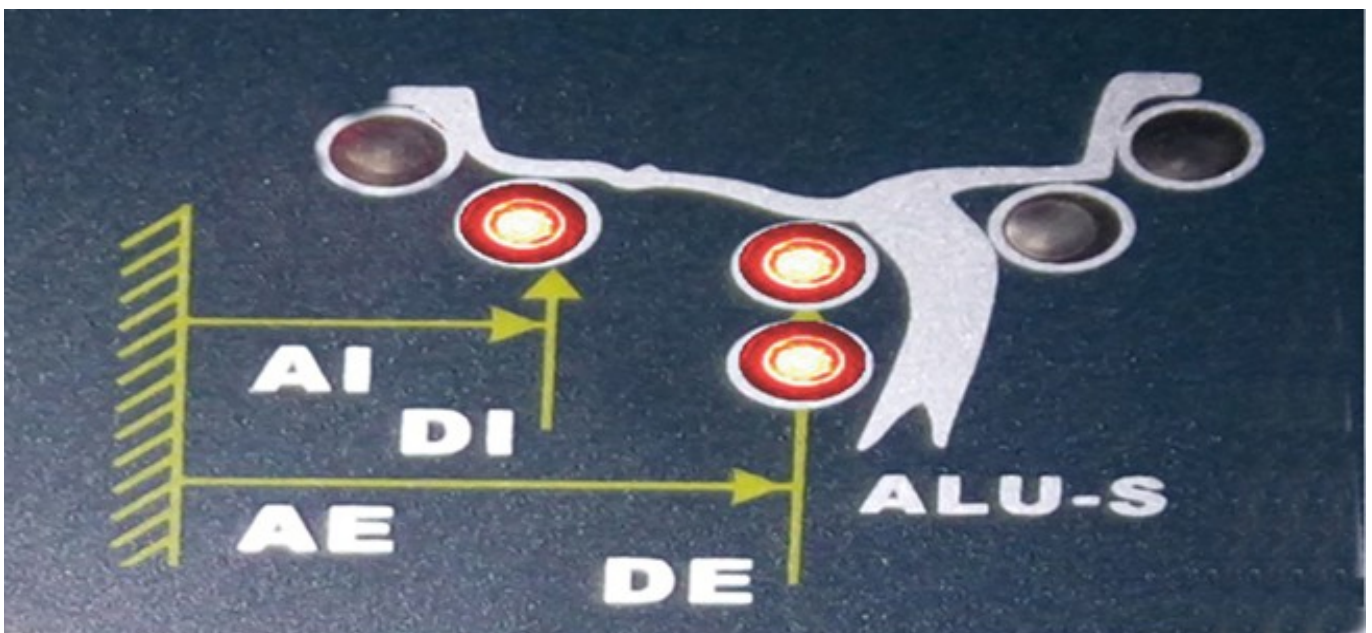





Or pull out the front measuring gauge into rim two position where apply weight on AI position and AE position. the system will automatic into ALU-S program





## For Manual Entry Model

Select positions of the rim to apply weights, take measurement of AI/DI and AE/DE.

AI	AE	DI	DE
Press  A+ and/or A- to enter the relevant <b>AI</b> .	Press  W+ and/or W- to enter the relevant <b>AE</b> .	Press  D+ and/or D- to enter <b>DI</b> .	Press  "<T" and use D+/D- to enter <b>DE</b> .
 	 	 	  



**ATTENTION**

Select an area of rim free of discontinuity, so that the weight can be applied in that position.

## 4.2 HIDE - WEIGHT PROGRAM

(available with ALU-S only)

### STEP 1

The HIDE weight program is to split 1 weight in the **OUTER** (right) plane into 2 weights placed in hidden positions behind 2 spokes of the alloy rim. Follow the ALU-S procedure, after the spin test done, press HIDE  key to enter the HIDE Weight Program, as shown in the display panel, the HIDE weight function indicator is light up,

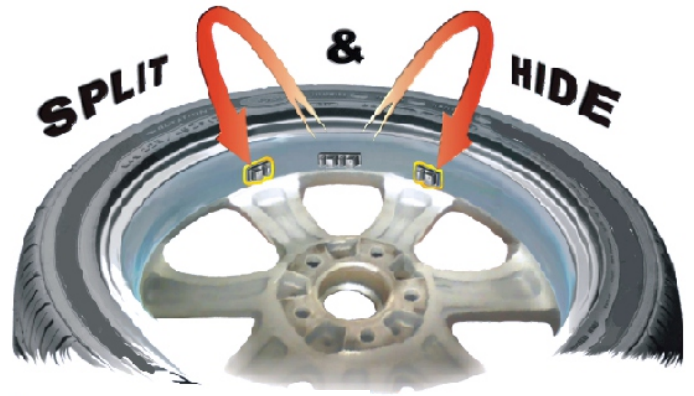

and the weight display windows shows

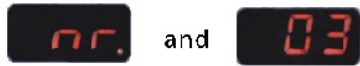

this indicates user to enter the number of rim spokes in the range from 3 to 12.

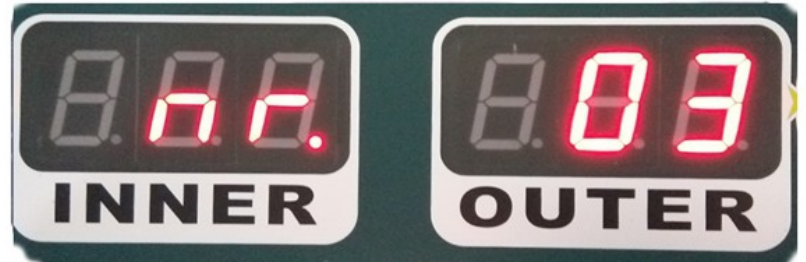



### STEP2

Select number of spokes



Press the A+ or A- key to modify the number of spokes. Press HIDE key to confirm.

### STEP3

Display shows  and . Rotate the wheel and point one of the spokes at TDC top dead center 12 o'clock position, Press HIDE key to confirm.

### STEP4

Press HIDE key to find the inner weight location. place the need weight on inner side. then Press HIDE key again to find outer weight location. place the need weight on the outer side.

In this stage, the **INNER** (left) weight window shows the reading of balancing weight that needs to be added onto user defined **INNER** (left) plane. The **OUTER** (right) weight window does not display any reading until one of the 2 target spokes points at TDC top center 12 o'clock position, corresponding weight will be prompted.



Step 1

Step 2

Step 3

Apply the **INNER** (left) weight with the same procedure described in section **ALU-S PROGRAM**. Press STOP  key to unlock the wheel for next step.

Rotate the wheel to line the first target spoke at the point that the position indication bar fully illuminated with beep sound, at this moment, the wheel is restrained automatically. The **OUTER** (right) weight display window shows the weight need to be added in first position behind the spoke.

Select the relevant weight and apply it as per the same procedure of weight application for **OUTER** (right) plane described in section **ALU-S PROGRAM**.

Press STOP  key to unlock the wheel and rotate the wheel to position of the 2nd spoke, repeat the above described procedure to apply the relevant weight behind the 2nd spoke.

Perform a test spin to check the accuracy.



## 4.3 STATIC BALANCING

Instead of applying weights on both **INNER** (left) and **OUTER** (right) side, to balance a wheel by using a single counter weight on a single position is called **Static Balancing**. A wheel can be balanced statically, however, ignoring dynamic unbalance will become more risky with an increasing of wheel width size.

Therefore static balancing is suitable for wheels with small width.

Perform a Standard Dynamic Balancing spin first to acquire readouts.

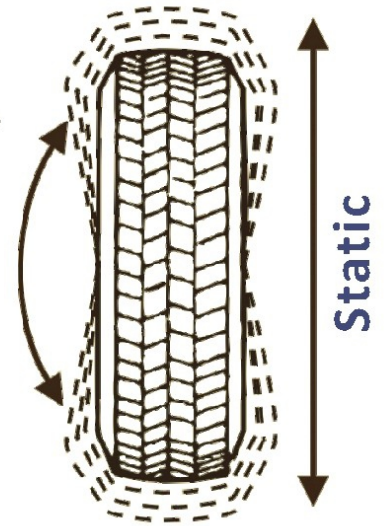

Press Fn



Key, the digits are:

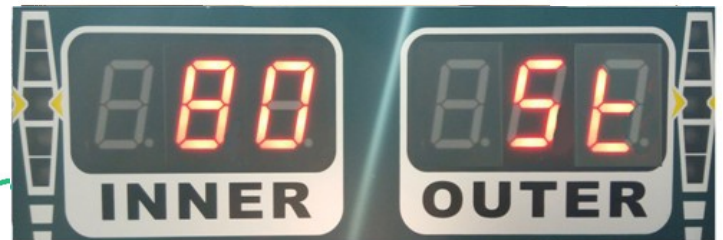

Display Panel in Standard Mode

With some (X) readings

That means **STATIC** Program is active.

The balancing weight location indicator shows:

LED Indicator for left clip on weight light up

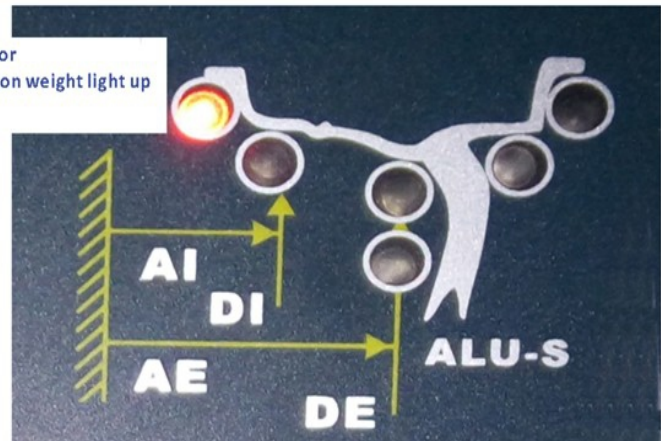

Press Fn



key again to re-enter to dynamic balancing mode.



The left weight display window shows the reading of measured static balancing result. Rotate the wheel, when both position indication bars are fully illuminated, apply the balancing weight in the 12 o'clock position on either left or right side, or at the center of the rim, indifferently.

However, when a balancing apply in the rim well, the diameter is smaller than the rated diameter, and it might change in different position selected. As a matter of fact, static balancing depends on diameter, to obtain correct result, diameter must re-entered with the aid of **APS (Alternative Plane Static)** program.

## 4.5 APS (ALTERNATIVE PLANE STATIC) PROGRAM (available with automatic data entry models only)

- 1 Press Fn and HIDE  +  Keys,



- 2   Pull out the front measuring arm, point the tip at the selected position (same method as used in ALU-S program), hold until the wheel data display windows are showing data (see example).

- 3 Return arm back to home (rest or "0") position)



- 4 Perform a wheel spin to get test result.

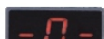

- 5 Rotate the wheel to TDC

- 6 Prepare an adhesive weight as per **INNER** (left) weight window indicated, center it to the cavity of weight holder terminal of the measuring arm, keep the adhesive strip facing the internal surface of the rim, move the measuring arm until the window A reads: 

- 7 Apply weight

Rotate the arm to line the adhesive weight to the rim surface, press the button of the weight holder eject the weight and make it stick firmly to the rim. Return the measuring arm to the rest position.



Press C  Key to exit the program.



## 4.8.8 MOTORCYCLE WHEEL BALANCING



Vehicle MODE Key to enter the motorcycle wheel balancing mode.

### Motor Cycle Wheel



Vehicle Type Indicator  
Motorcycle is on



Mount the wheel with motorcycle adaptor (optional kit).



### MC kits



### MC-XLT Kits

### 1 Motorbike STATIC



Motor Bike Static Balancing:  
Follow the procedure described in the section for STATIC BALANCING.

### 2 Motorbike DYNAMIC



Keys to enter dynamic program.

Motor Bike Dynamic Balancing:  
Follow the procedure described in the section for DYNAMIC BALANCING.



## ***Procedure of system calibration and parameter setting***

### **5.1** Balancing calibration

#### **Important**

Calibration is needed when:

- a) First time operation;
- b) Incorrect test result suspected.

#### **Calibration procedure:**

- 1) Put a medium size wheel, mount on the shaft and lock it well. Input the data of the rim.
- 2) Press and hold the key [F] and key [C]. The display reads: [CAL][CAL], hold the keys until the unbalancing position LED lights are on and blinking. Put down the protective cover and press [start] key.
- 3) After first spin, rotate the wheel until outer LED lights fully flash. The display reads: [ADD] [100], which indicates to add the 100g (3.5oz) calibration weight to the outer edge of the rim at the 12 o'clock position.

Put down the protective cover, or press [start] to proceed second spin. After the second spin, rotate the wheel until inner LED lights fully flash. The display reads: [ADD] [100], which indicates to add 100g (3.5oz) calibration weight to the inner edge of the rim at the 12 o'clock position.

Put down the protective cover, or press [start] to proceed with the third spin.

- 4) The calibration data will be memorized and the display will read: [End] [Cal].

If calibration fails, check for these error codes:

[Err][ -8-] forget to attach 100g or power board is out function.

[Err][ -9-] forget to attach 100g

[Err][ -6-] sequence of outer and inner attach 100g incorrect.

[Err][ -r-] hardware installation was not correct. calibration cannot completed.



## 5.2 DISTANCE **A** CALIBRATION (Available with Auto data entry models only)

### Step 1 :

Press Fn (and hold) use A+ or A- key, until the display shows:

**CAL**    **P 10**



### Step 2 :

Pull out the front measuring arm 100 mm position,

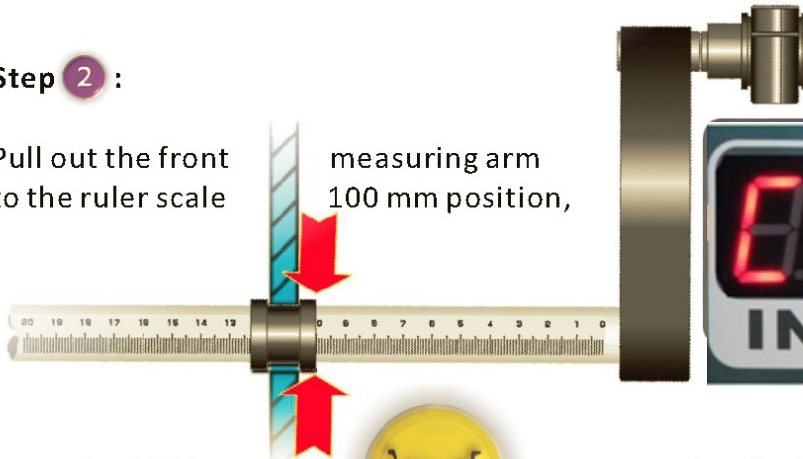

press the ALU key,



to see the display shows:



## 5.3 DIAMETER **D** CALIBRATION

### Step 1 :

Press Fn (and hold) use D+ or D- key, until the display shows

**CAL**    **-d-**



**PLEASE NOTE: These Parameters should not be changed without consulting a NHPProEquip.com service technician. Please call 603-234-2612 before attempting to change.**

### 5.4.1 SYSTEM PARAMETER SETTING

Replacing a new computer board requires the following:

Do the self calculation to save the settings.

5.4.1 turn on the machine.

5.4.2 press Fn+C together



The display will show this picture

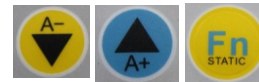

5.4.3 press A-, A+, Fn key in sequence (not together) to enter system parameter setting



Press B+ or B - to adjust the DF value of offset error.  
Press A+ to enter next parameter setting.

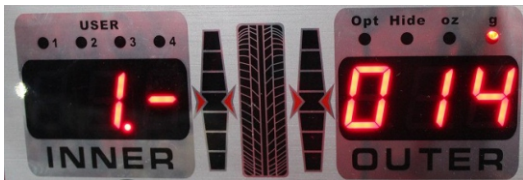

Press B+ or B - to adjust the I value of axial error.  
Press A+ to enter next parameter setting.



Press B+ or B - to adjust the S value of angle error.  
Press A+ to enter next parameter setting.

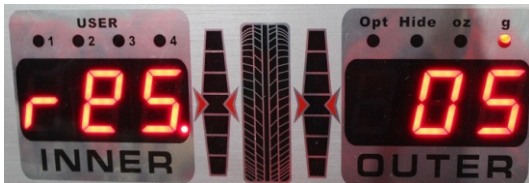

Press B+ or B - to adjust the RES value of Residual value of showing  
Press A+ to enter next parameter setting.

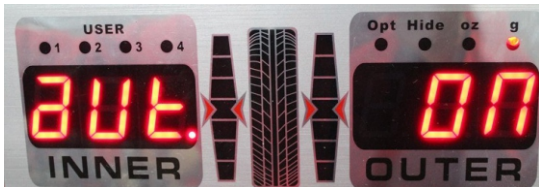

Press B+ or B - to adjust equip the width measuring arm.  
Press A+ to enter next parameter setting.



Press B+ or B - to adjust diameter measurement. (1 unit = 0.1 inch).  
Press A+ to enter next parameter setting.



Press B+ or B - to adjust laser pointer on or off.  
Press A+ to return homepage.